

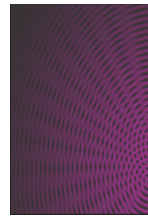

Admiral Series



HYDRAULIC STEERING FOR OUTBOARDS & STERNDRIVES



FOR OUTBOARDS

NON-FEEDBACK

Admiral Series

The **HyDrive Admiral Series** represents the pinnacle in outboard steering systems providing the highest corrosion resistance and strength of any steering system in its class. There is no direct equivalent from any other manufacturer.

Instead of the traditional anodised or coated aluminium cylinder barrels and tiller connections, the Admiral Series cylinders use high quality marine grade brass tubing for the barrels, solid brass end-caps and stainless steel tiller arms and connections. All brass components are further protected by Chrome plating for a high class finish that keeps the steering cylinder free from corrosion and pitting.

The Admiral Series cylinders are further protected from electrolysis by intelligent use of insulating materials and technology to electrically isolate the cylinder from the high voltage electrical discharge of the outboard motor's ignition system. It is the combined use of the best materials and insulation design that provides the most corrosion resistant outboard steering cylinders on the market anywhere.

The highly corrosive marine conditions of the tropical areas such as Asia, Northern Australia, Africa and Florida have met their match with the Admiral Series.

The Admiral Series comes with the standard 2 year warranty for commercial and leisure use.

Separate Data Sheets for each kit are available on our website with full dimensions of each component.

TYPICAL KIT

Each kit includes the following:-

- Model 401 Helm unit
- 2 litres Ultra-15 hydraulic fluid
- 15 metres high-pressure nylon hydraulic tubing
- The cylinder type of your choice
- All fittings to suit
- Bleeding kit
- All instructions



OBKIT1 pictured

Manufactured in Australia by
HyDrive Engineering Pty Ltd
50 Wingfield Road, Wingfield
South Australia 5013
Int Tel +61 8 82431633
Int Fax +61 8 84457938
Email: sales@hydrivedrive.com.au
Website: www.hydrivedrive.com.au

Admiral Series Helms

HyDrive, Australia's largest selling hydraulic steering for small boats, offers the finest in smooth, powerful steering, with quality and materials that are built to last. Large horsepower outboards are handled with comfort and without feedback from engine torque.

It doesn't matter whether you have a small boat with a small outboard, or a larger craft with multiple V-8's, there is a HyDrive Admiral to suit. Everything you need to handle virtually any boat using outboards, inboards, sterndrives or jet units from 4-15 Metres - delivered in a single carton!

The heart of the Admiral Series is the HyDrive Model 101 & 401 and 102 & 402 helm units. These 7-piston pumps are precision manufactured to standards and tolerances that are second to none. In-built lock valves, which eliminate torque feedback are standard. The light, smooth steering must be experienced to be appreciated.

Designed as a complete Do It Yourself installation, everything you need is supplied including detailed instructions. You don't even have to know anything about hydraulics!

Model 101 and 401
28cc/rev
Model 102 and 402
35cc/rev



Model 401 & 402

Model 401 Helm unit is standard in all kits. Other models are optional.



OPTIONAL Model 101 & 102
Mid-mount helm unit

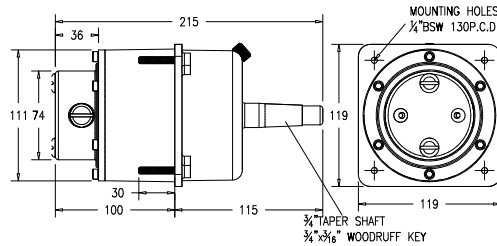

Compact, front-mount standard helm with minimal protrusion from the console (with rear-mount kit fitted)
Optional mid-mount or tilting helm style
In-built lock-valve eliminates torque feedback.
The wheel stays where you put it.
Field replaceable shaft seal.
Solid stainless steel helm shaft for optimum strength and durability.
Superior material choice - even the wheel nut and washer are brass.
4 precision bearings for smoothest performance.
All helms are built to High Performance standards - you don't pay more for HyDrive Power.



Fully tilting helm design
Model 101 - Tilt or 102 - Tilt

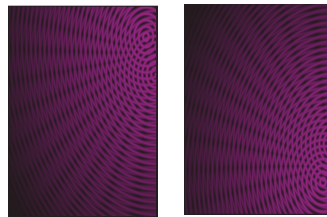
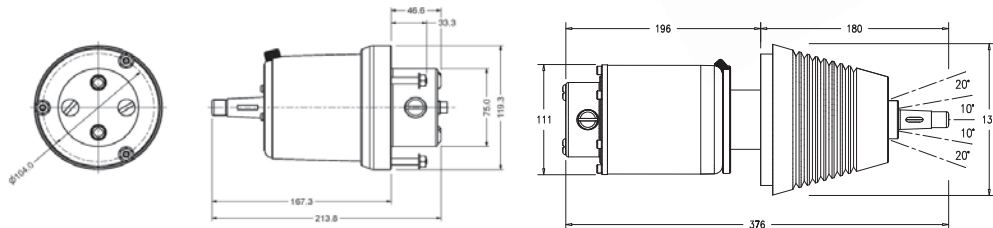

FOR OUTBOARDS

Front-mount Cylinders

BULL-HORN STYLE



211BH Bullhorn Cylinder

Powerful all bronze, brass and stainless steel construction sets apart from the others

For single outboard motors up to 300HP or twin motors up to 600HP total (counter-rotating), the 211BH is an ideal choice offering the advantage of full hydraulic control of your boat. Installation is simple with the cylinder attaching directly to the front of the outboard motor and supported from the motor's tilt-tube.

The compact design requires only 540mm clearance in the engine-well, considerably less than many of our competitors.

This cylinder comes in a complete kit - part number OBKIT1 Check the model selection chart for confirmation of the correct version to suit your particular motor.



211BH-XTN8

The strongest and most durable outboard steering cylinder of its type on the market

The model 211BH-XT is the perfect match for the Model 401 manual helm unit or for the POWERKIT-M12 12Volt DC power-steering system for large HP multiple-outboard installations. It has superseded the previous high-performance model 210BH-XT but has a more compact design with stronger mounting horns for optimum strength - and at a lower cost.

The solid stainless steel tiller arm and plate arrangement offers an operational strength far greater than alternative 'hinge' type cylinder designs and provides the best possible steering geometry for the tiller bolt, ensuring much safer operation under extreme conditions. The extra security of stainless wire retainers on all nuts makes this the ideal choice for commercial and heavy duty leisure applications where high performance and endurance is a must.

This cylinder comes in a complete kit - part number OBKIT1-XT Check the model selection chart for confirmation of the correct version to suit your particular motor.

211BH-XT FOR EXTREME PERFORMANCE



Front-mount Cylinders

BULL-HORN STYLE

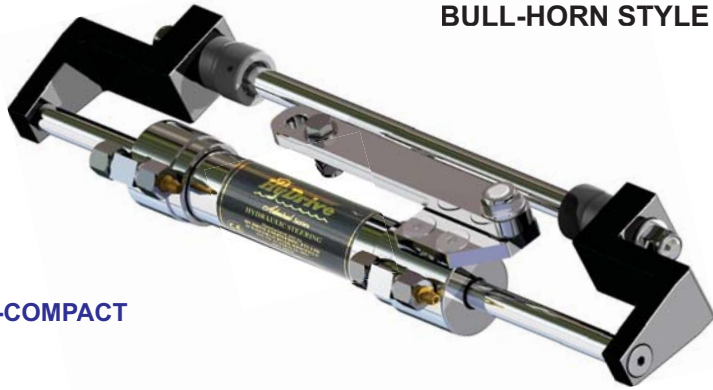

211BH-COMPACT

The model **211BH-COMPACT** Bullhorn cylinder is the latest addition to the new series of cylinders and is designed to replace the Limited-stroke model **212BH - PRO** cylinder.

As with the original **212BH** cylinder - this compact version of the 211BH cylinder is also a **limited-stroke** cylinder, having the same dimensions overall as the 212BH and also the same reduced stroke of only 7" or 178mm. **It should only be used in installations where the standard full-stroke cylinders such as the 211BH and 511BH are too wide to fit into a restricted engine-well or space.**

This cylinder comes in a complete kit - part number OBKIT1-COMPACT Check the model selection chart for confirmation of the correct version to suit your particular motor.



FOR OUTBOARDS

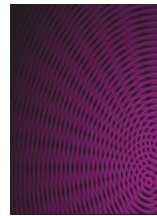

FOR OUTBOARDS

Side-mount Cylinders



210T Side-Mount Cylinder - can be used on outboards and stern-drives

The 210T is designed for installation directly onto the tilt-tube of the outboard motor in the same way as conventional cable steering. It attaches to the outboard motor's tiller arm using the motor's existing drag-link. This popular model can handle the same HP as the standard 211BH bullhorn type cylinder. It can also be fitted directly to the steering-cable bracket of a stern-drive (inboard/outboard).

The cylinder requires sufficient side clearance to fit, however the hoses remain stationary which makes it an ideal choice for many small boats. Installation is simple and performance is impressive when compared with conventional cable steering. It comes in two versions - Balanced and unbalanced, depending on the amount of room available for installation.

The 210T cylinder comes in kit form with all necessary fittings including high pressure nylon hydraulic tubing, 2 litres of Ultra-15 fluid, model 401 helm unit and detailed instructions.

OBKIT-2 - Balanced cylinder - supplied with 401 Helm unit .

OBKIT-3 - Single-ended (unbalanced) cylinder - supplied with 401 Helm unit.

Front-mount Cylinders

FIXED STYLE



216FM Front-Mount Cylinder

The 216FM is designed for installation directly onto most V4 and V6 outboards and mounts to the front of the motor using 4 small bolts. It attaches to the outboard motor's tiller arm using the motor's existing drag-link.

The cylinder requires more room than the bullhorn style cylinder, however the hoses remain stationary making it an ideal choice for wider engine wells. Installation is simple and performance is impressive when compared with conventional cable steering.

This cylinder comes in a complete kit - part number OBKIT5



Centre-mount Cylinders



210DE Double-Ended Centre-Mount Cylinder

The 210DE is designed for installation between two outboards, and connected by means of two drag-links to the two outboards' tiller arms. The most common position for mounting is under swim platforms, marlin boards or onto the transom. A popular means of hydraulically steering outboard powered catamarans, and relies on the installer to tailor two suitable drag-links or tie-bars to complete the installation.

The 210DE cylinder comes in kit form with all necessary fittings including high pressure nylon hydraulic tubing, 2 litres of Ultra-15 fluid, model 401 helm unit and detailed instructions.

This cylinder comes in a complete kit - part number OBKIT5



Accessories

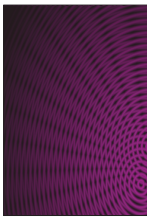

REAR-MOUNT KIT

The **REAR-MOUNT KIT** fits any model 401, 402 or 501 helm unit and is adjustable from low-profile to full protrusion for maximum flexibility in helm placement. Simply trim the spacers and studs to adjust the amount of protrusion into the helm position. The front dash or console ring is fully O-ring sealed against pump body to prevent water ingress to the rear of the console. Easy to fit, easy to adjust and looks great.

20 DEGREE WEDGE



The **WEDGE-401** 20-degree wedge kit is designed for mounting from fully horizontal to fully vertical installations and fits any standard model 401, 402 and 501 helm unit.

DO-IT-YOURSELF TIE-BAR KITS



- 1:- Stainless outer tube
- 2:- Stainless threaded rod
- 3:- Locking sleeves
- 4:- Rod-ends
- 5:- Tiller bolts (not shown)

The HyDrive UNITIEBAR is available for tie-bars up to maximum of 700mm between centres and up to twin 175HP outboards. For larger HP outboards - ask for a data sheet on our HD tie-bar kits.

FOR HELM UNITS

HYDRAULIC STEERING FOR OUTBOARD MOTORS

Typical steering circuits for outboard motors

Bullhorn type cylinders pictured but same circuits can be used on all cylinder types

