



Installation Guide

For Pro DC Electric Thruster Models

SEP80, SEP100, SEP120, SEP130, SEP150



SLEIPNER MOTOR AS

P.O. Box 519

N-1612 Fredrikstad

Norway

www.sleipnergroun.com

DOCUMENT ID: 2728

REVISION: I6

DATE: 2022

LANGUAGE: EN

MI

Contents

Installation Manual

Responsibility of the installer	3
General Installation Considerations and Precautions Guidelines	3
Product Measurements	4
Product Specifications	5
Proportional Technical Specifications	5
Positioning of the tunnel / thruster	6
Tunnel Length	7
Tunnel installation in sail boats	8
Water Deflection	9
Tunnel ends	10
Tunnel installation	11 - 12
Stern tunnel installation	13
Gear Leg & Motor Bracket Installation	14
Propeller Installation	15
Motor Installation	16
Electrical Installation	17
Product Lug Connection Configuration	17
Electrical Reference Guide	18
Visual Wiring Diagram	19
S-Link System Description	20
Control Panel Installation	21
Pre-delivery Checklist	22
Service and Support	23
Product Spare Parts and Additional Resources	23
Warranty Statement	23

Products

SEP80/185T-12V - SEP80 Tunnel thruster, 12V
SEP80/185T-24V - SEP80 Tunnel thruster, 24V
SEP100/185T-24V - SEP100 Tunnel thruster, 24V
SEP100/185T-12V - SEP100 Tunnel thruster, 12V
SEP120/215T-24V - SEP120 Tunnel thruster, 24V
SEP130/250T-24V - SEP130 Tunnel thruster, 24V
SEP130/250T-12V - SEP130 Tunnel thruster, 12V
SEP150/215T-24V - SEP150 Tunnel thruster, 24V

Responsibility of the Installer

The installer must read this document to ensure necessary familiarity with the product before installation.

Instructions in this document cannot be guaranteed to comply with all international and national regulations. It is the responsibility of the installer to follow all applicable international and national regulations when installing Sleipner products.

The recommendations given in this document are guidelines ONLY, and Sleipner strongly recommends that advice is obtained from a person familiar with the particular vessel and applicable regulations.

This document contains general installation instructions intended to support experienced installers. If you are not skilled in this type of work, please contact professional installers for assistance.

If required by local regulation, electrical work must be done by a licensed professional.

Appropriate health and safety procedures must be followed during installation.

Faulty installation of Sleipner products will render all warranties given by Sleipner Motor AS.

General Installation Considerations and Precautions Guidelines

For thruster systems

- Do not install the thruster in a position where you need to cut a stiffener/ stringer/ support that may jeopardise the hull integrity without checking with the boat builder this can be done safely.
- We advise painting the gear house and propellers with anti-fouling. **(NB: Do not paint the anodes, sealing, rubber fittings or propeller shafts)**
- There is only room for a thin coat of primer and two layers of anti-fouling between the tunnel and the props.
- Never run the thruster out of water.

For electric motor thrusters

- The thruster must NOT be installed in compartments that require ignition proof electric equipment. If necessary, make a separate compartment. **(NB: Ignition Protected systems are tested to be installed in areas with possible explosive gases in accordance with ISO 8846)**
- When installing the thruster electric motor in small compartments, ensure the compartment is well ventilated to allow for cooling of the electro motor.
- If the height of the room you are installing the thruster is limited, the thruster can be installed horizontally or at any angle in-between.
 - If the electro motor is positioned more than 30 degrees off vertical, it must be supported separately.
 - Beware of keeping installation within advised measurements. No part of the propeller or gear house must be outside the tunnel.
- The electric motor, components and cables must be mounted so they remain dry at all times.
- Do not finish the inside of the tunnel with a layer of gel-coat/ topcoat or similar. There is only room for a thin coat of primer and two layers of anti-fouling between the tunnel and the props.
- Don't install the electric motor close to easily flammable objects or equipment as it will reach over 100°C before the temperature switch is activated.
- Do not store items close to the thruster motor. Any loose items near the thruster motor is a potential fire hazard and can cause undesired short-circuiting.
- Do not lift it by internal cable connections, main terminals.
- The thruster power supply circuit must include the recommended sized fuse and a battery isolation switch.
- The electric/ hydraulic motor must be handled with care. Do not rest the thruster motor on its drive shaft as its weight can damage the shaft.

For DC electric motors

- The electro motor will generate some carbon dust so any storage compartments must be separated from the thruster to prevent nearby items becoming dusty/ dirty. **(NB: IP version motors generate dust but are enclosed.)**

Lithium Batteries for proportional thrusters models SEP, SEP-IP and eVision

- If a lithium battery system is installed for supply of SEP, SEP-IP or eVision thrusters, make sure the battery is designed for continuous supply of the required thruster current. Under-rated battery management system can suddenly disconnect the load which may lead to dangerous situations. The firmware version of Proportional Power Controller (PPC) must be of version 1.033 or later if the PPC is to be connected to a lithium battery. Operating the thruster outside specified ratings will void warranty.

When installing an S-Link™ system DO NOT connect any other control equipment directly to the S-Link™ bus except original Sleipner S-Link™ products. In case of connecting third-party equipment, it must always be connected through a Sleipner-supplied interface product.

Any attempt to directly control or connect into the S-Link™ control system without a designated and approved interface will render all warranties and responsibilities of all of the connected Sleipner products.

If you are interfacing the S-Link™ bus by agreement with Sleipner through a designated Sleipner supplied interface, you are still required to install at least one original Sleipner control panel to enable efficient troubleshooting if necessary.

Measurement code	Measurement description	SE80 _{12v}		SE80 _{24v}		SE100 _{12v}		SE100 _{24v}		SE120 _{24v}		SE130 _{12v}		SE130 _{24v}	
		mm	inch	mm	inch	mm	inch	mm	inch	mm	inch	mm	inch	mm	inch
ID	Internal tunnel diameter	185	7,28	185	7,28	185	7,28	185	7,28	215	8,46	250	9,84	250	9,84
H	Motor Height	352	13,86	344	13,54	393	15,47	393	15,47	394	15,51	398	15,67	398	15,67
W	Width	252	9,92	261	10,28	292	11,50	272	10,71	266	10,47	296	11,65	277	10,91
L	Length	206	8,11	206	8,11	240	9,45	240	9,45	243	9,57	250	9,84	249	9,80
WD	Water Depth	185	7,28	185	7,28	185	7,28	185	7,28	215	8,46	250	9,84	250	9,84
TL	Minimum tunnel length	179	7,05	179	7,05	179	7,05	179	7,05	233	9,17	253	9,96	253	9,96
TL (recommended)	Recommended tunnel length	216	8,50	216	8,50	216	8,50	216	8,50	276	10,87	303	11,93	303	11,93
T (min)	Minimum tunnel wall thickness	6	0,24	6	0,24	6	0,24	6	0,24	7	0,28	7	0,28	7	0,28
T (max)	Maximum tunnel wall thickness	8	0,31	8	0,31	8	0,31	8	0,31	9	0,35	9	0,35	9	0,35

Measurement code	Measurement description	SE150 _{24v}	
		mm	inch
ID	Internal tunnel diameter	215	8,46
H	Motor Height	412	16,22
W	Width	292	11,50
L	Length	245	9,65
WD	Water Depth	215	8,46
TL	Minimum tunnel length	233	9,17
TL (recommended)	Recommended tunnel length	276	10,87
T (min)	Minimum tunnel wall thickness	7	0,28
T (max)	Maximum tunnel wall thickness	9	0,35

*Valid for SE & SEP

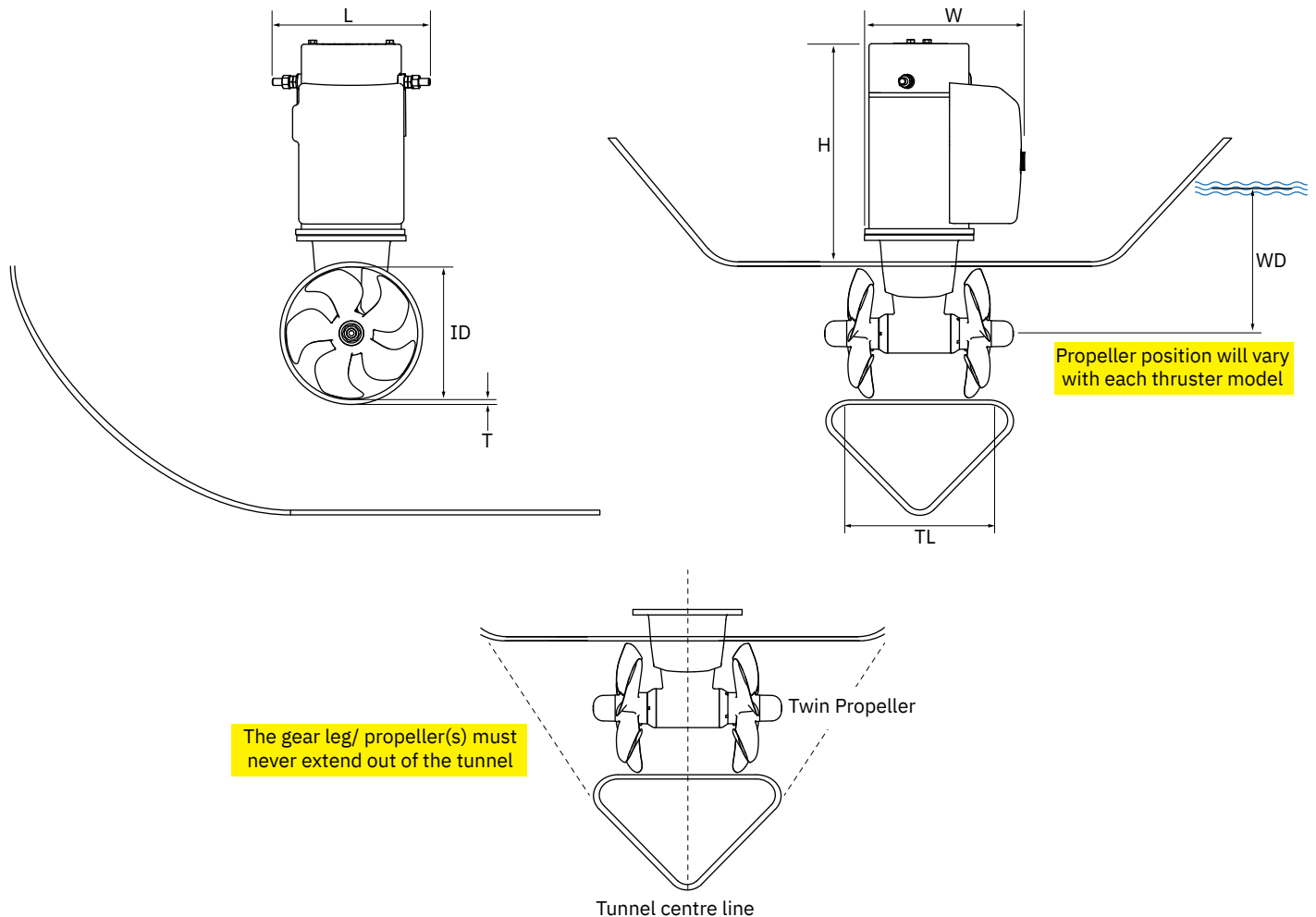

Product	Maximum Operating Power * Maximum supply voltage **	Thrust at 12V or 24V	Thrust at 10.5V(12V) or 21V(24V)	Power (kw / Hp)	Weight (kg / lbs)	Maximum Operation Time
SE 80	12V	96 kg / 212 lbs	80 kg / 176 lbs	4.4kw / 6hp	20kg / 44lbs	S2 motor at 2 - 3 min. Duty cycle at 20°C (Ambient temperature)
	24V	96 kg / 212 lbs	80 kg / 176 lbs	4.4kw / 6hp	20kg / 44lbs	
SE 100	12V	116 kg / 256 lbs	100 kg / 220 lbs	6.3kw / 8.4hp	31kg / 68lbs	
	24V	116 kg / 256 lbs	100 kg / 220 lbs	6.3kw / 8.4hp	31kg / 68lbs	
SE 120	24V	139 kg / 306 lbs	120 kg / 264 lbs	6.4kw / 8.55hp	34kg / 74lbs	
SE 130	12V	160 kg / 352 lbs	130 kg / 284 lbs	6.5kw / 8.7hp	37kg / 77lbs	
	24V	160 kg / 352 lbs	130 kg / 284 lbs	6.5kw / 8.7hp	37kg / 77lbs	
SE 150	24V	182 kg / 400 lbs	150 kg / 330 lbs	8.8kw / 11.8hp	38kg / 79lbs	

* SE and SE-IP are measured at motor terminals when the thruster is operated for on/off thrusters

** SEP and SEP-IP are measured at PPC supply terminals for proportional thrusters

Proportional Technical Specifications

Safety features: - The PPC Speed Control unit will turn off motor power each time the main solenoids are activated. This removes any possibility for solenoid lock-in. Any fault in the main solenoids will give feedback to the panel and turn off power to the electric motor.

Aim to install the thruster as far forward as possible (1)

Due to the leverage effect around the boats' pivot point. The distance difference from the boat pivots' point to the thruster will determine the amount of real rotation power for the boat.

Aim to install the thruster as deep as possible under the waterline (2)

Deeper installations prevent air from being sucked into the tunnel from the surface, resulting in reduced thrust performance and increase noise levels during operation. Deeper installations increase water pressure for maximum efficiency from the thruster.

The centre of the tunnel should be a minimum of 1 x the tunnel diameter below the waterline. The installer must make evaluations based on thruster performance, boat type and operating conditions. As a general recommendation, the position of the tunnel should not be a minimum of 1/4 of the diameter of the tunnel from the boat keel. **(NB: This can be overlooked depending on the installation methods defined in this manual.)**

1

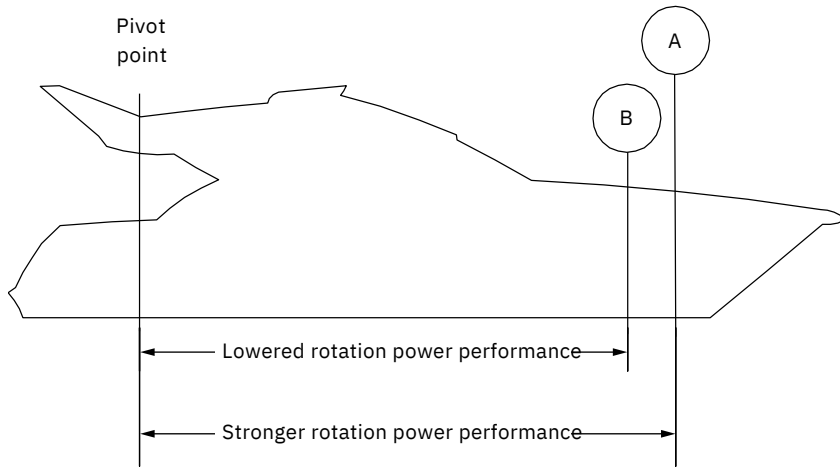

2

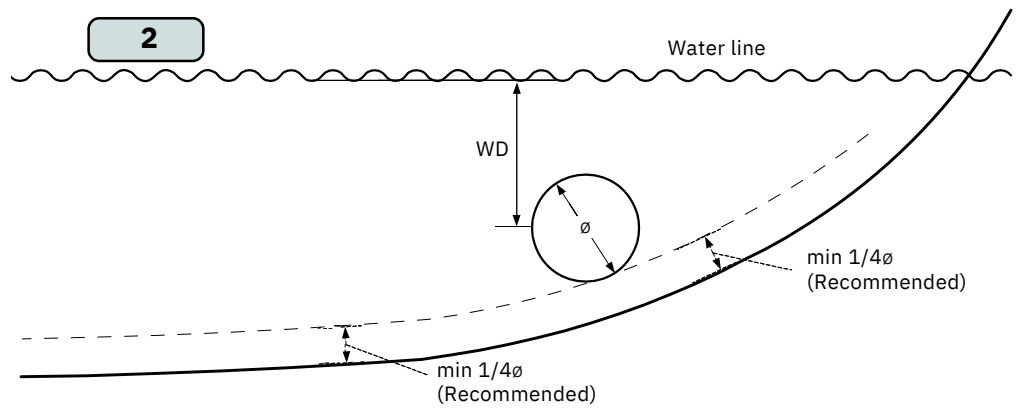

MG_0001

Optimal tunnel length

Achieving the correct tunnel length depends on many factors from the hull type, operation and environmental conditions.

Tunnels should avoid being longer than 4 x the tunnel diameter as this will reduce thruster performance. **(NB: Installing long length tunnels can flex/bend over time and may require additional support. Consult with a naval architect.)**

1. Do not allow the variable length of the tunnel walls to vary in length excessively.
EG. The top tunnel wall is x 4 longer than the bottom wall.
2. If the tunnel is too long, the friction inside will reduce the water speed and thereby the thrust.
3. If the tunnel is too short (typically only in the bottom section of the tunnel) cavitation problems can occur as water flow will not be able to "straighten" itself before reaching the propeller. This cavitation will reduce performance and increase noise during operation.

Thruster within the tunnel

It is important the propellers and the lower unit/ gear leg must be entirely inside the thruster tunnel. Propellers that protrude from the tunnel will not perform as intended.

4. Standard Use

Tunnel length must be long enough to ensure the propellers are not extruding the tunnel.

5. Flat Bottom Hull

Tunnel lengths must be longer than the standard measurement outlined within the manual to ensure a circular vacuum is not created between the thruster and the bottom of the boat.

6. High-Speed Boats

Tunnel lengths must be increased to protect the propeller from damage when crashing against the water surface during high-speed cruising. **(NB: This can include the length of a spoiler)**

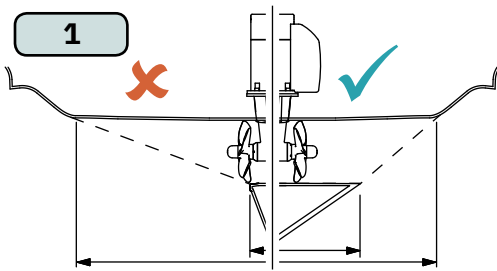

Do not allow the variable length of the tunnel walls to vary in length excessively.
EG. the top tunnel wall is x 4 longer than the bottom wall.

3

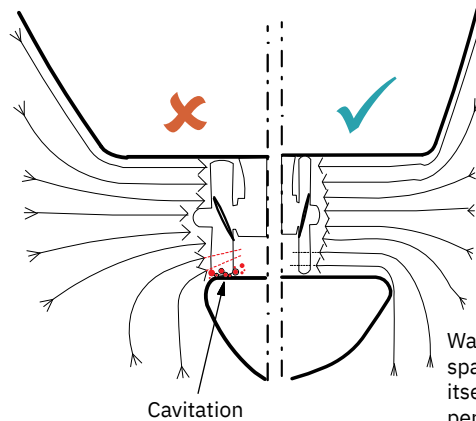

Water flow must have space to "straighten" itself for best performance.

2

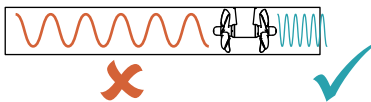

4 STANDARD USE

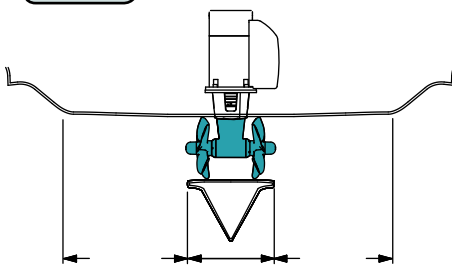

The gear leg/ propeller(s) must never extend out of the tunnel

5 FLAT BOTTOM HULL

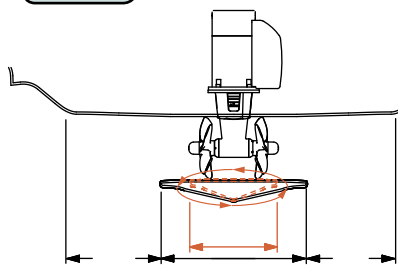

Increase tunnel length to prevent a circular water vacuum cavity between the propeller and the hull of the boat.

6 HIGH-SPEED OPERATION

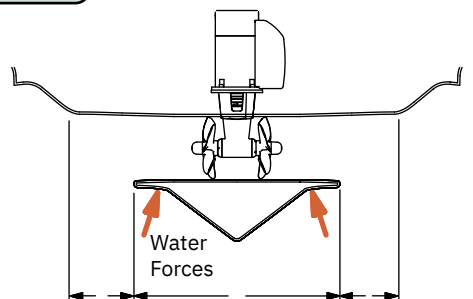

Increase tunnel length to protect the propeller from water forces when high-speed cruising.

MG_0048

Some sail boats have a flat bottom and shallow draft in the bow section. This can make installing the thruster as far forward from the boats main pivot point difficult. **(Fig. 1).**

However, it is possible to install a tunnel thruster in most sail boats, even when the hull does not directly support the fitting of a tunnel.

Instead fit the tunnel halfway into the underneath section of the existing hull. Strengthen it with a deflector/ spoiler directing the water flow around the tunnel. This will allow installation of the thruster in the proper position on the boat, maintaining the reliability and space advantages of the tunnel thruster.

This installation is being used by some of the world's largest sail boat builders and has proven to give little to no speed loss during normal cruising. This can also be an installation method for flat bottomed barges to avoid extremely long tunnels and large oval tunnel openings in the hull.

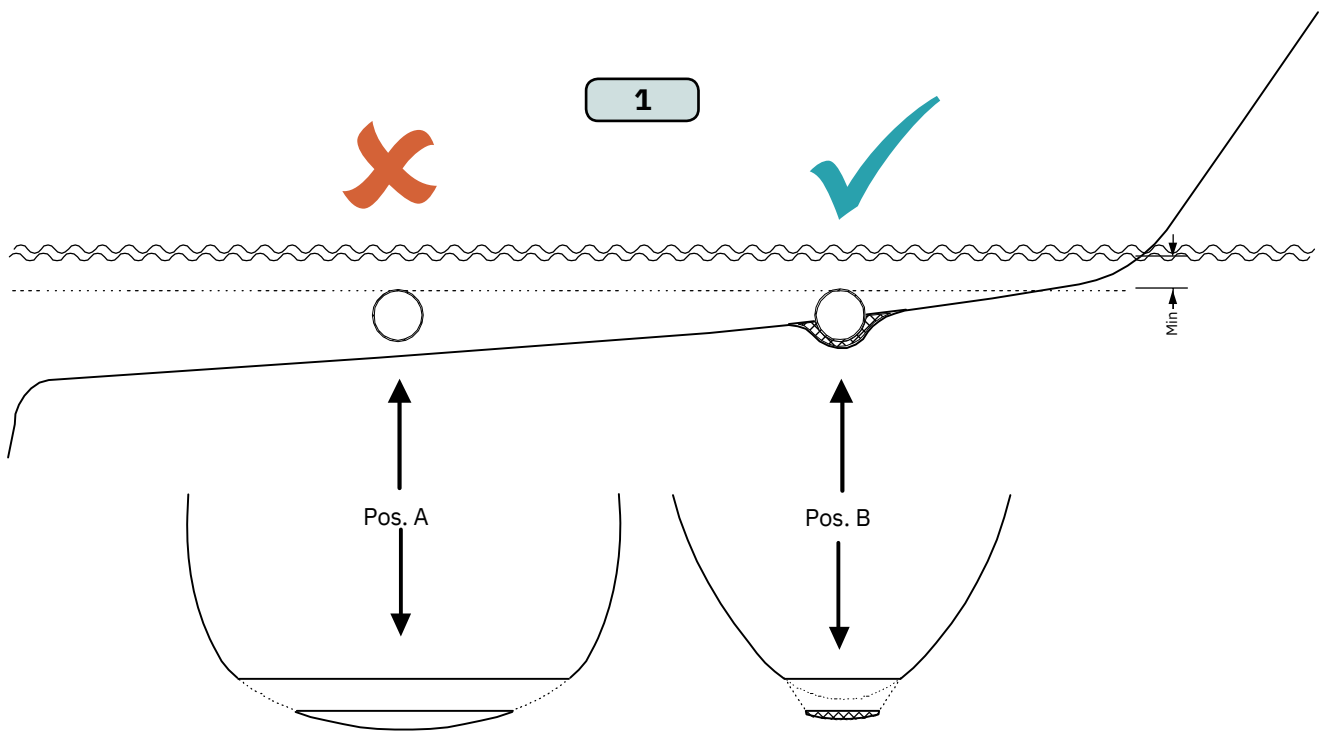

1. A possible problem in sail boats or fast powerboats is that a non-rounded surface can generate drag from the back face of the tunnel, as it creates a "flat" area facing the flow of water.

This problem can be solved in two different ways, depending on what is possible or easier to perform.

2. The best solution which generally reduces the most drag is to make a recess in the hull at the back of the tunnel. As the back face is removed water can flow freely past the tunnel entry. The depth and shape of this recess will depend on the boat and the angle facing up/ down aft of the tunnel insert. Normally it is angled slightly down because of the water flow on this area.
3. Making a deflector/ spoiler in front and underneath the tunnel can also reduce damage to the thruster and drag. The deflector/ spoiler will push the water flow out from the hull so water can pass by the back face of the tunnel. The shape and size of this deflector/ spoiler will depend on the hull shape. The easiest way of making the deflector/ spoiler is to retain a part of the lower forward area of the tunnel while installing the tube. Use this area as support to mould a soft curve/spoiler shape from the hull.
4. The thruster propeller can spin (passively) producing noise while sailing or cruising as water is forced through the tunnel. Water-flow directed through the tunnel at high speeds, during turning or as the boat bumps waves while underway can also damage the thruster.

(NB: As a rule, you should not see the back face of the tunnel when standing directly in front of the boat looking aft.)

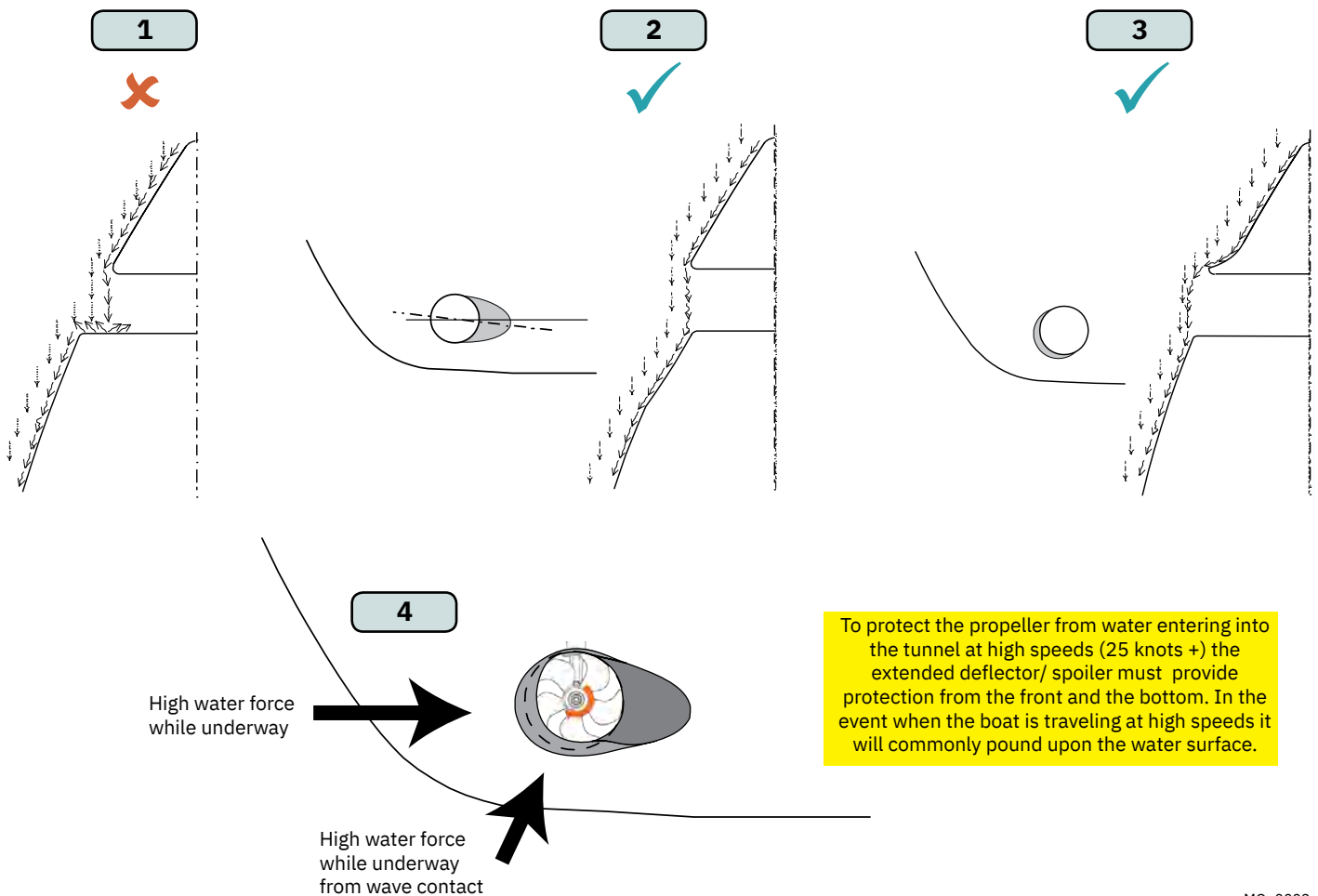

Rounded tunnel ends will maximise thrust and minimise noise and cavitation.

For best performance round the tunnel connection to the hull-side as much as possible. The minimum rounding has a radius of 10% of the diameter of the tunnel.

Significant advantages of a rounded tunnel over a sharp tunnel to hull connections are:

1. A rounded tunnel end will prevent the creation of turbulence/ cavitation created from a sharp tunnel end when water passes by the tunnel.
 - The turbulence/ cavitation will block the outer area of the tunnel and thereby reduces the effective tunnel diameter and thrust.
 - Turbulence/ cavitation on the propeller will lessen the thrusters performance and create excess noise.
2. For steel/ aluminium hulls angled tunnel ends also offer similar performance as a rounded connection.
3. A rounded tunnel end makes the thruster draw water from along the hull-side, creating a vacuum that will suck the boat sideways and thereby give additional thrust.
 - With a sharp tunnel end, the thruster will be unable to take water from along the hull-side, and you will not gain the desired vacuum and additional thrust. This “free” extra thrust in optimal installations be 30 - 40% of the total thrust.

(NB: A Side-power thruster propeller does not produce cavitation at working speed. Therefore, any cavitation and cavitation noise in the tunnel will be caused during improper tunnel installation.)



IMPORTANT

We recommend that a professional does the fibreglass, steel or aluminium fitting of the tunnel. These instructions are only general instructions and do not explain in any way the details of fibreglass work. Problems caused by faulty installation of the tunnel, are the installers full responsibility.

1. Find the position in the boat considering the information earlier in this manual and the applicable measurements for the thruster model you are installing. Mark the centre of the tunnel on both sides of the hull. Drill a hole horizontally at these marks.
2. Mark the circle for the tunnel opening (outside diameter of the tunnel) and cut the hole.
3. Grind off the gel coat to the “real fibreglass” area 12cm around the hole on both inside and outside the hull to cast the tunnel to the hull (**Fig. 3**).
4. Insert the tunnel and mark its shape to fit the hull. (**NB: if you are installing with a deflector/ spoiler, leave a part of the tunnel in the front and underside of the tunnel that will cover the back face.**)
5. Cut the tunnel ends to the desired shape and lightly sand its surface. Clean the area with acetone or similar where you are going to apply fibreglass. (**NB: Do not cast or add fibreglass to the area were the thruster will be placed.**)
6. Cast the tunnel to the inside of the hull, use at least eight layers of 300g fibreglass and resin, preferably alternating mat and rowing types of fibreglass. To round the tunnel ends to a 10% radius make further layers inside to preserve the desired hull thickness.

(NB: Ensure gaps between the tunnel and the hull are completely filled with resin/ fibreglass. In areas where you can not access to make layers of resin/ fibreglass, a resin/ fibreglass mixture must be used in that area.)

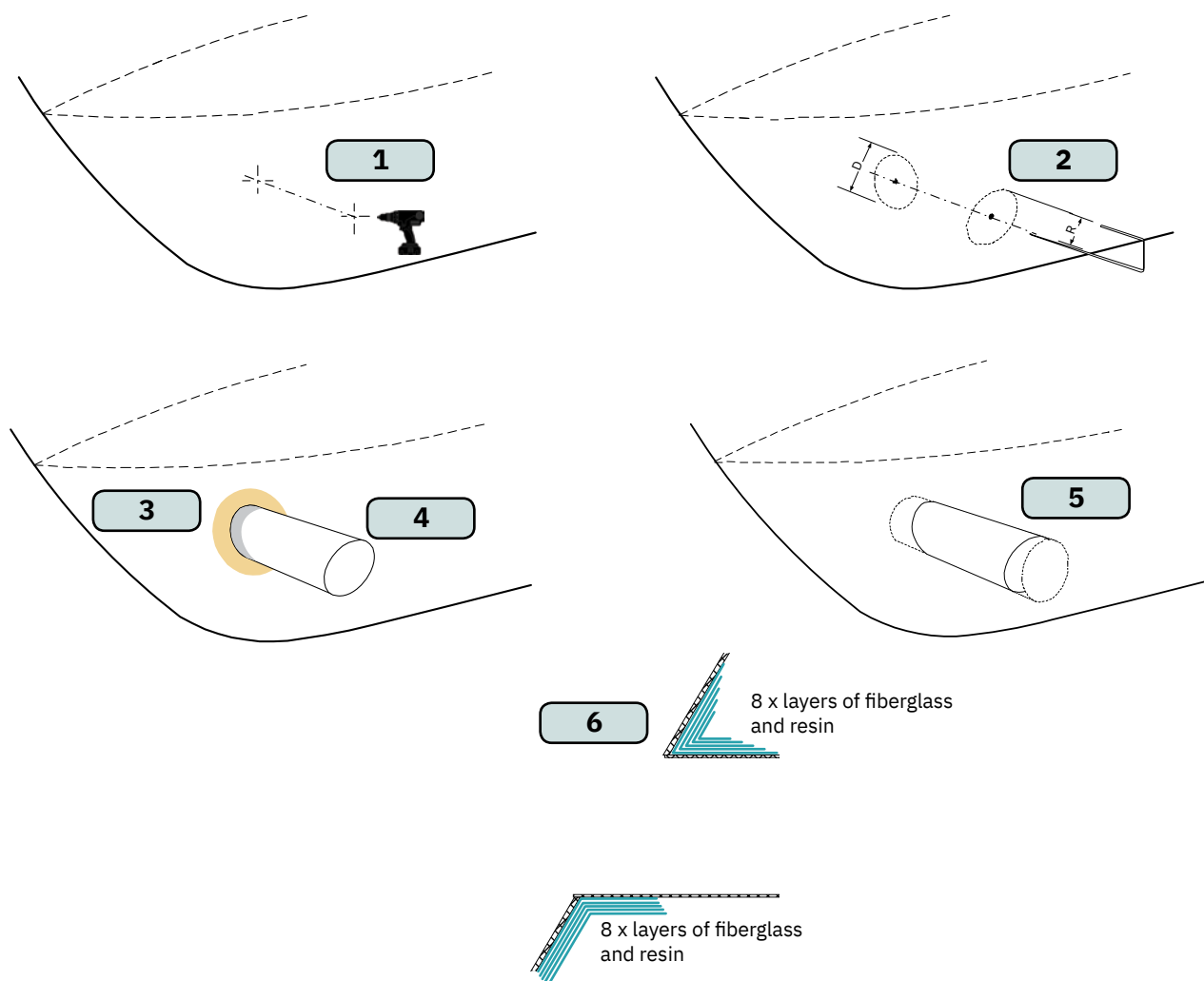

With tunnel installed and cast.

1. Round the edges with a radius of 10% of the tunnel diameter.
2. For steel/ aluminium hulls make a slope with a length of 10-15% of the tunnel diameter.
(NB: If this is not possible, round the tunnel end as much as possible.)
3. Additionally cast two layers on the outside of the tunnel/ hull in a 10cm area
4. Follow the same method if making the deflector/ spoiler.

You must apply gel coat to areas you have grounded/ moulded to make waterproof. These areas allow water access to the hull which is typically not waterproof without these applications outside. **(NB: All original Side-Power tunnels are fully waterproof when delivered except in the areas where you have cut and bonded it to the hull.)**

IMPORTANT
 Avoid all casting where the motor-bracket is to be placed, as this will cause misfit and possible failure to the gear house.

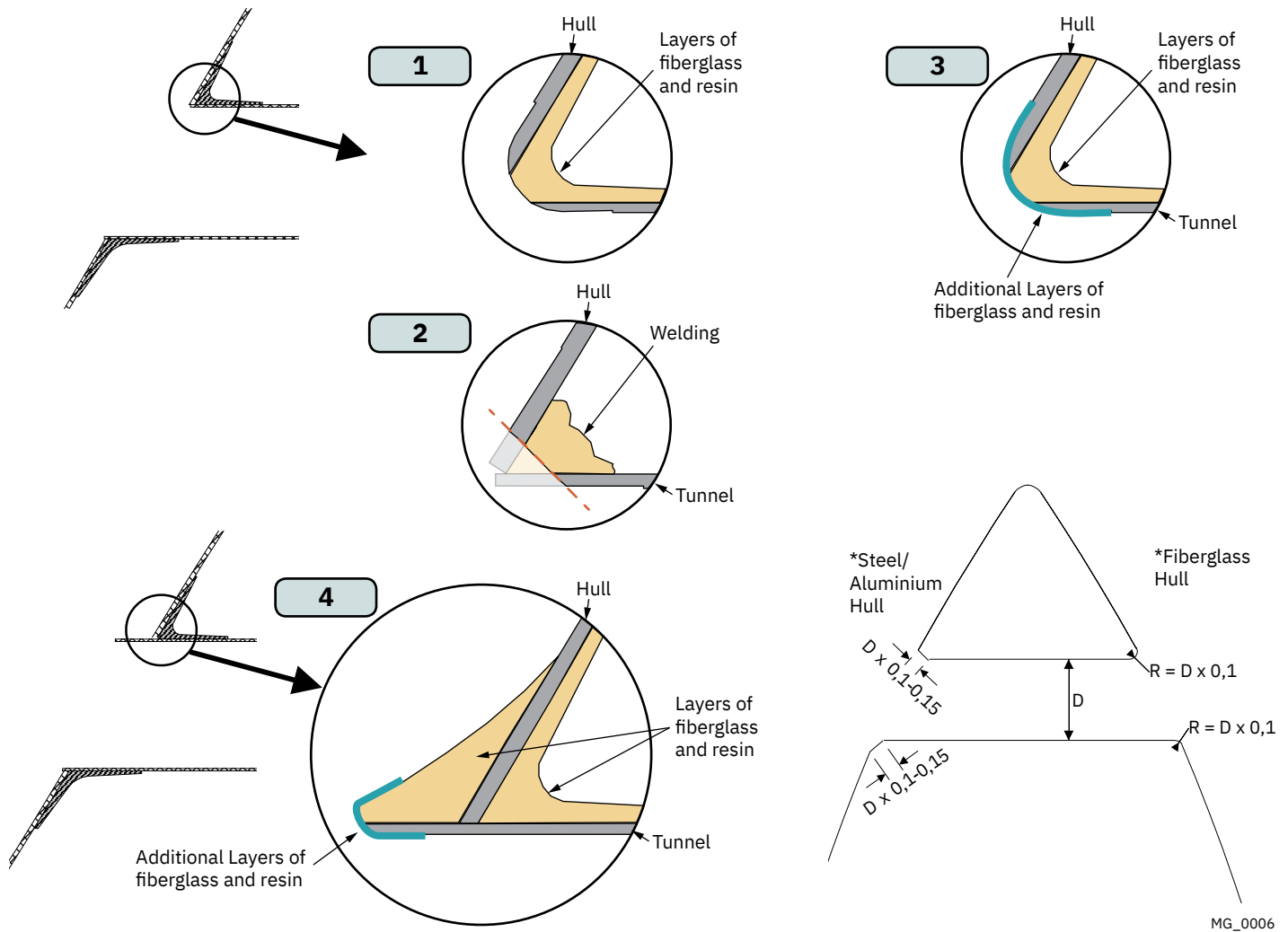

For **Stern Thruster** installation please refer to the supplied manual in your Sleipner product delivery



! Please refer to the graphic for special considerations relating to your model !

1. Mark the tunnel centreline and the boat's centreline. **(NB: Install the gear leg and propeller as shown above for the thrust direction to correspond with the control panel. Position gear leg with the P-mark facing port and the S-mark facing starboard.)**
2. Use the gasket or template (recommended) to mark the hole centres and double-check the measurements. The centre hole MUST be placed using the boat centreline as shown above. **(NB: All holes must be in-line with the tunnels' centreline for correct installation, clearance between the propeller and the tunnel is minimal.)**
3. Smooth the surface of the tunnel. A rough surface will cause possible failure/movement of the gear leg. The motor bracket must rest steadily on the tunnel.
4. Drill the main centre hole followed by the two screw-holes.
5. Place the gear leg (without the propeller) with the gasket on inside the tunnel. Place the propeller on the gear leg to ensure it is centred and rotates freely with the same clearance from each blade to the tunnel wall. Place top motor bracket to measure the drive shaft has come through the motor bracket at the correct height. Remove the gear leg and propeller for final installation.
6. Apply appropriate sealant to both sides of the gasket and place on the gear leg. Place the gear leg in the tunnel (without the propeller).
7. Install the top motor bracket and gear leg gently together.
8. Fasten the gear leg and the motor bracket with the bolts provided. Fasten to torque as shown above.

1

Boats centre line
Tunnel centre line
Bow
Stern
PORT
STARBOARD

2 - 4

Tunnel centre line
Boats centre line
Bow
ØA
B
ØC

Measurement Description	SE*P*IP 80		SE*P*IP 100		SE*P*IP 120		SE*P*IP 130		SE*P*IP 150		SE*P*IP 170		SE*P*IP 210	
	mm	inch	mm	inch	mm	inch	mm	inch	mm	inch	mm	inch	mm	inch
ØA	34	1.33	47	1.85										
B	28	1.1	40	1.57										
ØC	9	0.35	12	0.43										

*P- Propositional
*IP- Ignition Protected

5

Gasket
Bow
Ensure propeller turns without obstruction

6 - 7

Apply MS Polymer sealant or equal to both sides of the gasket
Motor bracket
Bow
IMPORTANT Do not apply sealant to the holes.

8

Bow

SE*P*IP 80
SE*P*IP 100
FASTEN
18 Nm
(13.28 lb/ft)

SE*P*IP 120
SE*P*IP 130
SE*P*IP 150
SE*P*IP 170
SE*P*IP 210
FASTEN
33 Nm
(24 lb/ft)

! Please refer to the graphic for special considerations relating to your model !

1. Centre the drive pin and Insert the propeller onto the shaft spline. Rotate the propeller until the drive pin aligns with the internal slot in the propeller.
2. Insert the washer to the end of the shaft spline. Tighten with the propeller lock-nut.
3. Insert the anode to the end of the propeller and tighten the anode holding screw. Apply a thread glue (Loctite 243 or similar) to ensure that the anode holding screw does not unscrew itself from during the rotation of the propeller.
4. Apply anti-fouling to the gear leg and propeller. Do not apply anti-fouling to any rubber elements of the gear leg or anodes.

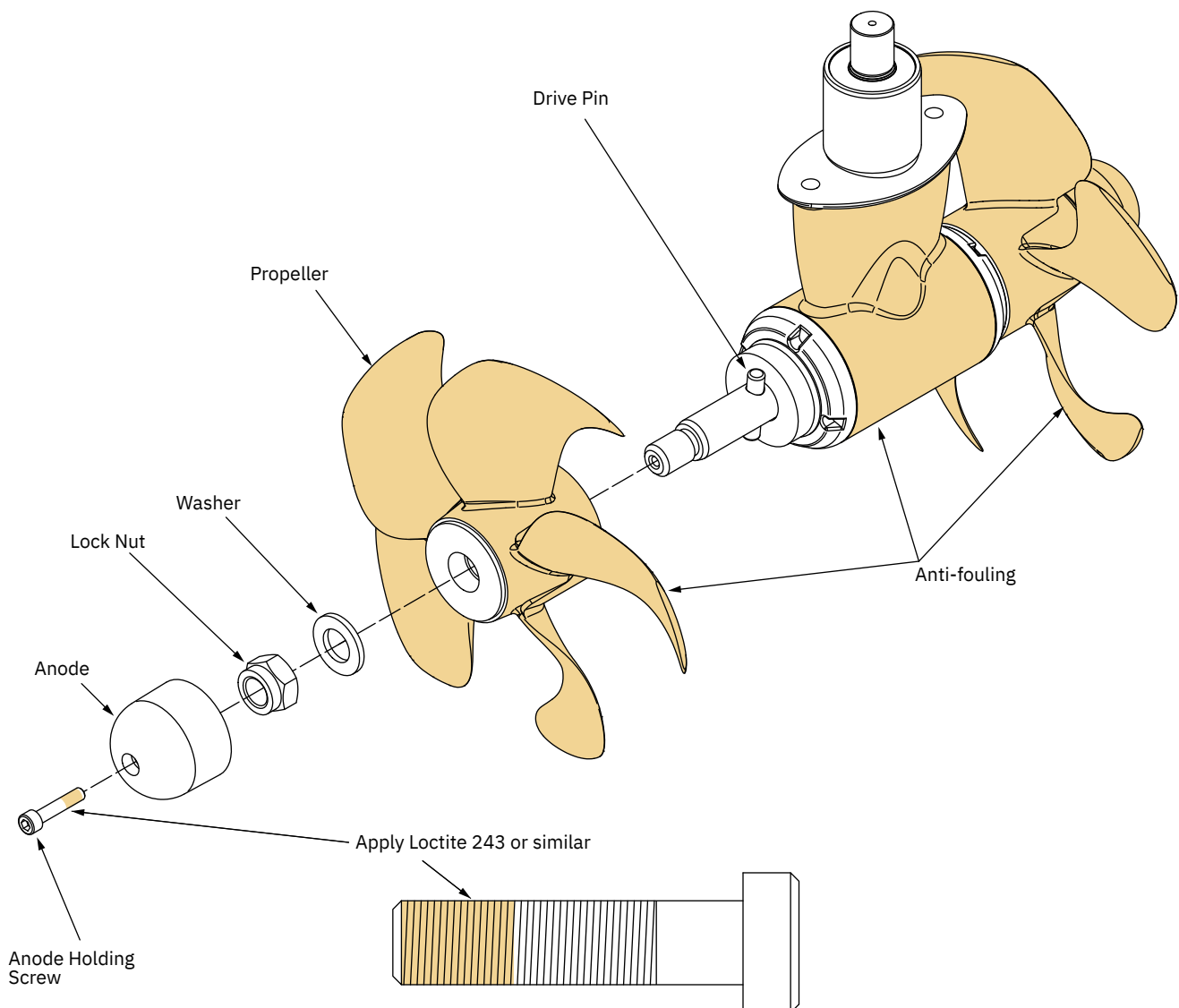

MG_0033

! Please refer to the graphic for special considerations relating to your model !

1. Install the motor onto the motor bracket ensuring the couplings are engaged together correctly (top and bottom). **(NB: The motor can be placed in all directions on the motor bracket. However, ensure the cable terminals are accessible for electrical installation later.)**
2. If you are installing the motor at an angle of more than 30 degrees off vertical, the motor will require separate/ additional support. **(NB: Do not position supports on the motors top cap.)**
3. Fasten the bolts holding the motor to the motor bracket with the above torque.
4. Check the drive shafts are engaged by rotating the propeller. **(NB: Rotating the propellers can be hard due to the gear reduction and the motor, however the propeller must be able to rotate via hand power.)**

IMPORTANT

The thruster motor assembly must be protected using suitable covering to avoid dust/debris ingress from fabrication/maintenance/shipbuilding operations. On completion of operations, the cover must be removed before operating the thruster.

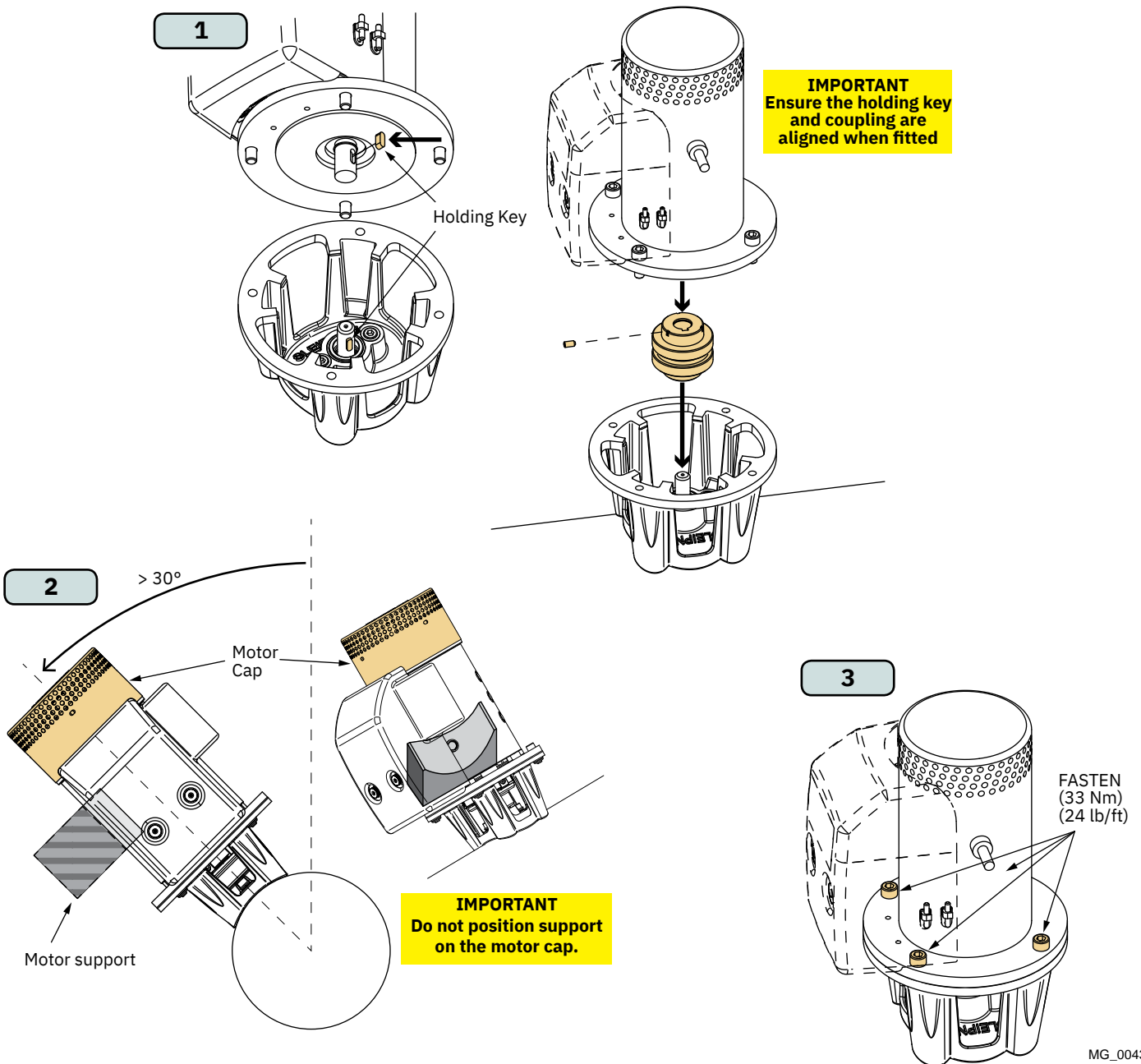

MG_0043

1. Plan the location of electrical components before starting with the electrical installation. Main electrical components will typically consist of battery, Automatic Main Switch (AMS) or manual main switch, Proportional Power Controller (PPC) and motor, see Wiring Diagram chapter for an overview.
2. Estimate the total length of the power cables to determine the recommended cross section. The total power cable length is defined as the distances from the positive battery pole, via fuse, main switch and PPC to the motor and all the way back to the negative battery pole. Compromising the cable sections named B+, M- and B- on the drawing in the Wiring Diagram chapter.
3. Find the recommended power cable cross section for you installation by using the estimated total power cable length and the table shown in *Electrical Reference Guide* chapter
4. Find the recommended fuse size by using the table shown in *Electrical Reference Guide* chapter. Use slow blow rated fuses to hold stated nominal current for minimum 5 minutes.
5. Use appropriate dimensioned battery with Cold Cranking Amps (CCA) according to recommendations in *Electrical Reference Guide* chapter. Battery voltage must be compliant with the voltage rating of the thruster motor and control circuitry. Capacity and rated discharge current of battery should be according to rated nominal current drawn and typical duty cycle for thruster operation. Nominal current drawn is listed in the Cross Section Guide for Power Cables chapter. The actual voltage at the motor while running the thruster determines the motor RPM and thrust. Use larger cable cross section and high-capacity battery for improved performance.
6. Install the cable from the as described in chapter Installation of Actuator Cable.
7. Install the PPC according to instructions in PPC Installation chapter.
8. Install and connect the battery, fuse, main switch and wiring according to instructions in Wiring Diagram chapter. For safety reasons it is always recommended to install a fuse and a main switch on the power cables and as close as possible to the positive battery pole connection. The main switch must be installed such that it is easily accessible to disconnect the thruster when not on-board or in the case of an emergency.

Follow the instructions in the Motor Lug Connection chapter when fastening the power cables to the motor.

Sleipner offers both manual main switches and Automatic Main Switches (AMS). Sleipner AMS is controlled by the control panel in addition to the option of manual operation. Turning on the control panel does also turn on the automatic main switch. When the control panel is turned off the automatic main switch is also turned off. This ensures that the control electronics and motor is only energized when the control panel is turned on. Sleipner offers AMS supporting either S-Link or ON/OFF control panels. Ensure to select a main switch with voltage rating according to the chosen motor- and battery-voltage. Note that the AMS requires separate power supply which should be protected by a dedicated fuse.

WARNING

After all electrical connections have been completed, turn off main switch and check the following with an ohmmeter:

1. There is no electrical connection between electro-motor flange and the positive terminal on the motor.
2. There is no electrical connection between electro-motor flange and the negative terminal on the motor.

If unsure contact skilled personnel.

Product Lug Connection Configuration

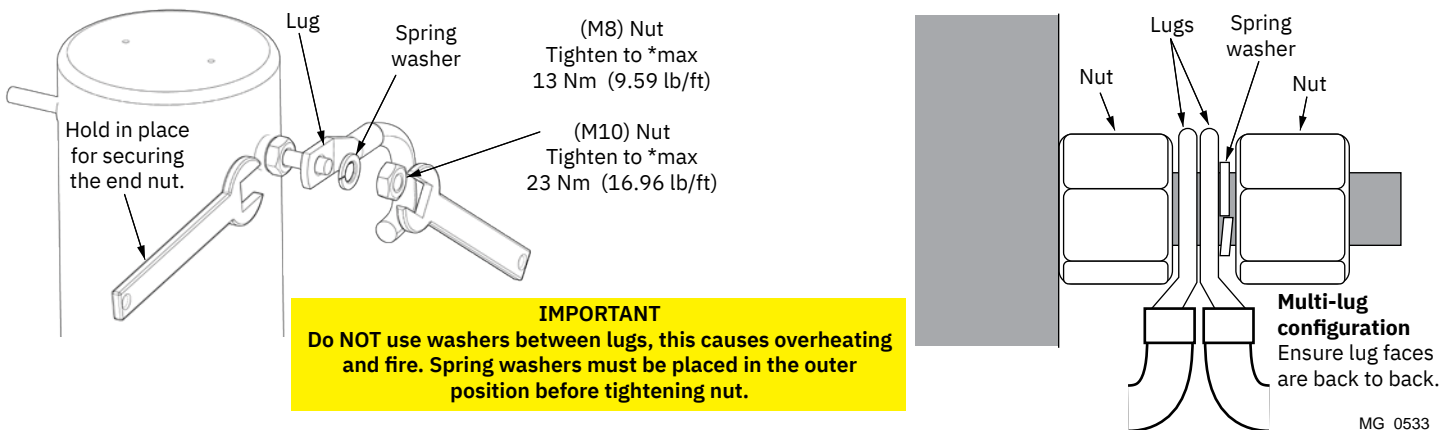

Model Size	System Voltage	Nominal current	*Min. battery CCA	Rec. fuse	Cross Section Guide for Power Cables													
					Unit	<7m total + & -		7-14m total + & -		15-21m total + & -		22-28m total + & -		28-35m total + & -		36-45m total + & -		
						Min.	Rec.	Min.	Rec.	Min.	Rec.	Min.	Rec.	Min.	Rec.	Min.	Rec.	
20/110S	12V	150 A	DIN: 200 SAE: 380 EN: 330	ANL 150	mm ²	25	35	35	50	50	70	70	95	95	95	120	2 x 70	
					AWG	3	2	2	1/0	1/0	2/0	2/0	3/0	3/0	3/0	3/0	2 x 4/0	2 x 2/0
25/110S	12V	200 A	DIN: 200 SAE: 380 EN: 330	ANL 150	mm ²	25	35	50	50	70	70	95	95	120	120	2 x 70	2 x 70	
					AWG	3	2	1/0	1/0	2/0	2/0	3/0	3/0	4/0	4/0	2 x 2/0	2 x 2/0	
30/125S 30/140	12V	245 A	DIN: 200 SAE: 380 EN: 330	ANL 150	mm ²	35	50	50	70	70	95	95	120	120	2 x 70	2 x 70	2 x 95	
					AWG	2	1/0	1/0	2/0	2/0	3/0	3/0	4/0	4/0	2 x 2/0	2 x 2/0	2 x 3/0	
40/125S 40/140	12V	315 A	DIN: 300 SAE: 570 EN: 520	ANL 250	mm ²	35	50	70	95	95	120	120	2 x 70	2 x 95	2 x 95	2 x 120	2x 120	
					AWG	2	1/0	2/0	3/0	3/0	4/0	4/0	2 x 2/0	2 x 3/0	2 x 3/0	2 x 4/0	2 x 4/0	
50/140S	12V	370 A	DIN: 350 SAE: 665 EN: 600	ANL 325	mm ²	50	50	70	95	120	2 x 70	2 x 70	2 x 95	2 x 95	2 x 120	2 x 120	2 x 120	
					AWG	1/0	1/0	2/0	3/0	4/0	2 x 2/0	2 x 2/0	2 x 3/0	2 x 3/0	2 x 4/0	2 x 4/0	2 x 4/0	
	24V	170 A	DIN: 175 SAE: 332 EN: 280	ANL 150	mm ²	25	25	25	35	35	50	35	50	50	50	70	70	70
					AWG	3	3	3	2	2	1/0	2	1/0	1/0	2/0	2/0	2/0	2/0
60/185S 60/140	12V	370 A	DIN: 350 SAE: 665 EN: 600	ANL 325	mm ²	50	50	70	95	120	2 x 70	2 x 70	2 x 95	2 x 95	2 x 120	2 x 120	2 x 120	
					AWG	1/0	1/0	2/0	3/0	4/0	2 x 2/0	2 x 2/0	2 x 3/0	2 x 3/0	2 x 4/0	2 x 4/0	2 x 4/0	
	24V	170 A	DIN: 175 SAE: 332 EN: 280	ANL 150	mm ²	25	25	25	35	35	50	35	50	50	50	70	70	70
					AWG	3	3	3	2	2	1/0	2	1/0	1/0	2/0	2/0	2/0	
80/185T	12V	530 A	DIN: 550 SAE: 1045 EN: 940	ANL 400	mm ²	70	70	120	2 x 70	2 x 95	2 x 95	2 x 120	2 x 120	2 x 120	NA	NA	NA	
					AWG	2/0	2/0	4/0	2 x 2/0	2 x 3/0	2 x 3/0	2 x 4/0	2 x 4/0	2 x 4/0	NA	NA	NA	
	24V	280 A	DIN: 300 SAE: 570 EN: 520	ANL 250	mm ²	35	35	35	50	50	70	70	95	95	120	120	2 x 95	
					AWG	2	2	2	1/0	1/0	2/0	2/0	3/0	3/0	4/0	4/0	2 x 3/0	
100/185T	12V	740 A	DIN: 750 SAE: 1425 EN: 1320	ANL 500	mm ²	95	95	2 x 70	2 x 95	2 x 120	NA	NA	NA	NA	NA	NA	NA	
					AWG	3/0	3/0	2 x 2/0	2 x 3/0	2 x 4/0	NA	NA	NA	NA	NA	NA	NA	
	24V	340 A	DIN: 400 SAE: 760 EN: 680	ANL 325	mm ²	50	50	50	70	70	95	95	120	120	2 x 95	2 x 95	2 x 120	
					AWG	1/0	1/0	1/0	2/0	2/0	3/0	3/0	4/0	4/0	2 x 3/0	2 x 3/0	2 x 4/0	
120/215T	24V	420 A	DIN: 450 SAE: 855 EN: 760	ANL 325	mm ²	70	70	70	70	70	95	95	120	120	2 x 70	2 x 70	2 x 95	
					AWG	2/0	2/0	2/0	2/0	2/0	3/0	3/0	4/0	4/0	2 x 2/0	2 x 2/0	2 x 3/0	
130/250T	12V	800 A	DIN: 750 SAE: 1425 EN: 1320	ANL 500	mm ²	95	95	2 x 95	2 x 95	2 x 120	2 x 120	NA	NA	NA	NA	NA	NA	
					AWG	3/0	3/0	2 x 2/0	2 x 3/0	2 x 4/0	2 x 4/0	NA	NA	NA	NA	NA	NA	
	24V	350 A	DIN: 400 SAE: 760 EN: 680	ANL 325	mm ²	50	50	50	70	70	95	95	120	120	2 x 70	2 x 95	2 x 95	
					AWG	2	1/0	1/0	2/0	2/0	3/0	3/0	4/0	4/0	2 x 2/0	2 x 3/0	2 x 3/0	
150/215T	24V	610 A	DIN: 560 SAE: 1064 EN: 940	ANL 500	mm ²	70	70	95	95	120	120	2 x 70	2 x 95	2 x 95	2 x 120	2 x 120	2 x 120	
					2	2/0	2/0	3/0	3/0	4/0	4/0	2 x 2/0	2 x 3/0	2 x 3/0	2 x 4/0	2 x 4/0		
170/250TC	24V	550 A	DIN: 560 SAE: 1064 EN: 940	ANL 400	mm ²	70	70	70	95	95	120	120	2 x 95	2 x 95	2 x 95	2 x 120	2 x 120	
					AWG	2/0	2/0	2/0	3/0	3/0	4/0	4/0	2 x 3/0	2 x 3/0	2 x 3/0	2 x 4/0	2 x 4/0	
210/250TC	24V	500 A	DIN: 560 SAE: 1064 EN: 940	ANL 400	mm ²	70	70	70	95	95	120	120	2 x 70	2 x 70	2 x 95	2 x 95	2 x 120	
					AWG	2/0	2/0	2/0	3/0	3/0	4/0	4/0	2 x 2/0	2 x 2/0	2 x 3/0	2 x 3/0	2 x 4/0	
250/300TC	24V	610-670 A	DIN: 700 SAE: 1330 EN: 1170	ANL 500	mm ²	70	70	95	120	120	2 x 95	2 x 95	2 x 95	2 x 95	2 x 120	2 x 120	2 x 120	
					AWG	2/0	2/0	3/0	4/0	4/0	2 x 3/0	2 x 3/0	2 x 3/0	2 x 3/0	2 x 4/0	2 x 4/0	2 x 4/0	
300/300TC	24*2	400-450A (48V)	DIN: 400 SAE: 760 EN: 680	ANL 325	mm ²	50	70	50	70	70	95	95	120	120	120	140	NA	
	48V				AWG	1/0	2/0	1/0	2/0	2/0	3/0	3/0	4/0	4/0	4/0	4/0		

Wiring Diagram

Selection of battery, fuse, main switch and cable cross section is described in *Electrical Installation* chapter.

Refer to the User and Installation Manual of the control panel to be installed for detailed installation instructions.

See S-Link System Description chapter for detailed information on installation of S-Link Power cable and additional S-Link components.

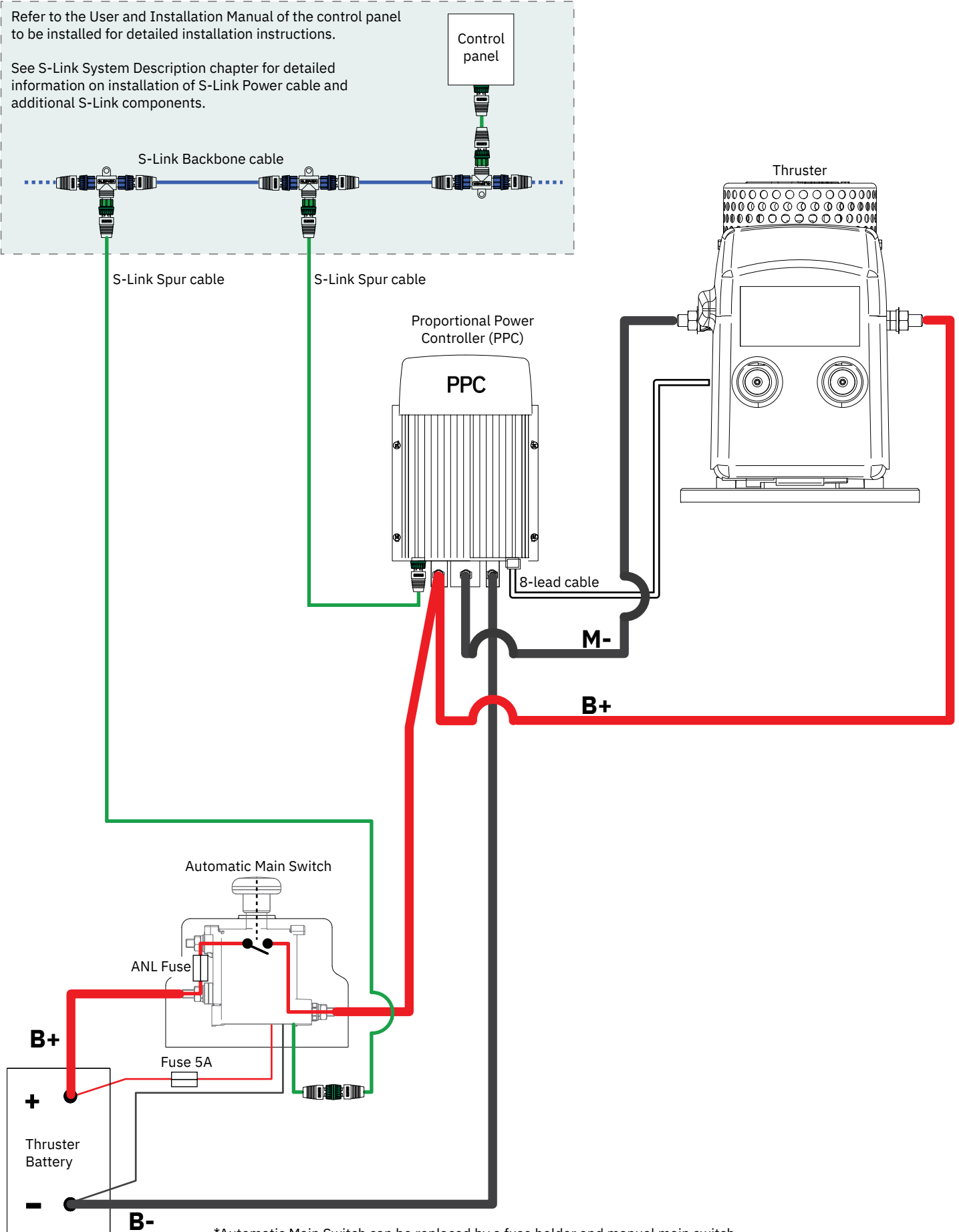

*Automatic Main Switch can be replaced by a fuse holder and manual main switch.

MG_0561

S-Link is a CAN-based control system used for communication between Sleipner products installed on a vessel. The system uses BACKBONE Cables as a common power and communication bus with separate SPUR Cables to each connected unit. Units with low power consumption are powered directly from the S-Link bus therefore one power cable must be connected to the BACKBONE Cable through a T-Connector.

Main advantages of S-Link system:

- Compact and waterproof plugs.
- BACKBONE and SPUR Cables have different colour coding and keying to ensure correct and easy installation. BACKBONE Cables have blue connectors and SPUR Cables have green connectors.
- Different cable lengths and BACKBONE Extenders makes the system scalable and flexible to install.

Installation of S-Link cables:

Select appropriate cables to keep the length of BACKBONE- and SPUR Cables to a minimum. In case of planned installation with total BACKBONE Cable length exceeding 100 meters please consult your local distributor. The S-Link cables should be installed to ensure sharp bend radius's is avoided. Locking mechanism on connectors must be fully closed. To ensure long lifetime, cables, T-Connectors and Extenders should not be located so that they are permanently immersed in water or other fluids. It is also recommended to install cables such that water and condensation do not run along the cables and into the connectors.

The POWER Cable should ideally be connected around the middle of the BACKBONE Cable to ensure an equal voltage drop at each end of the BACKBONE Cable. The yellow and black wire in the POWER Cable shall be connected to GND and the red wire connected to +12VDC or +24VDC.

To reduce the risk of interference, avoid routing the S-Link cables close to equipment such as radio transmitters, antennas or high voltage cables. The backbone must be terminated at each end with the END Terminator.

SPUR cables can be left unterminated to prepare for the installation of future additional equipment. In such cases, ensure to protect open connectors from water and moisture to avoid corrosion in the connectors.

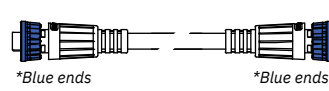

BACKBONE Cable
Forms the communication and power bus throughout a vessel. Available in different standard lengths.

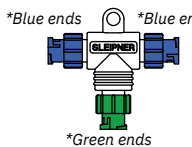

T-Connector
Used for connection of SPUR or POWER Cable to the BACKBONE Cable. One T-Connector for each connected cable.

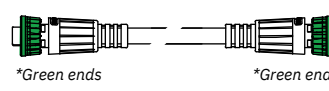

SPUR Cable
Used to connect S-Link compliant products to the backbone cable. One SPUR Cable must be used for each connected component, with no exceptions. Recommended to be as short as practically possible. Available in different standard lengths.



BACKBONE Extender
Connects two BACKBONE Cables to extend the length.

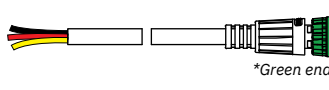

POWER Cable
Required in all installations for connection of BACKBONE Cable to a power supply. It shall not be more than one POWER Cable in an installation.

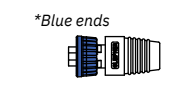

END Terminator
Must be one at each end of the BACKBONE bus.

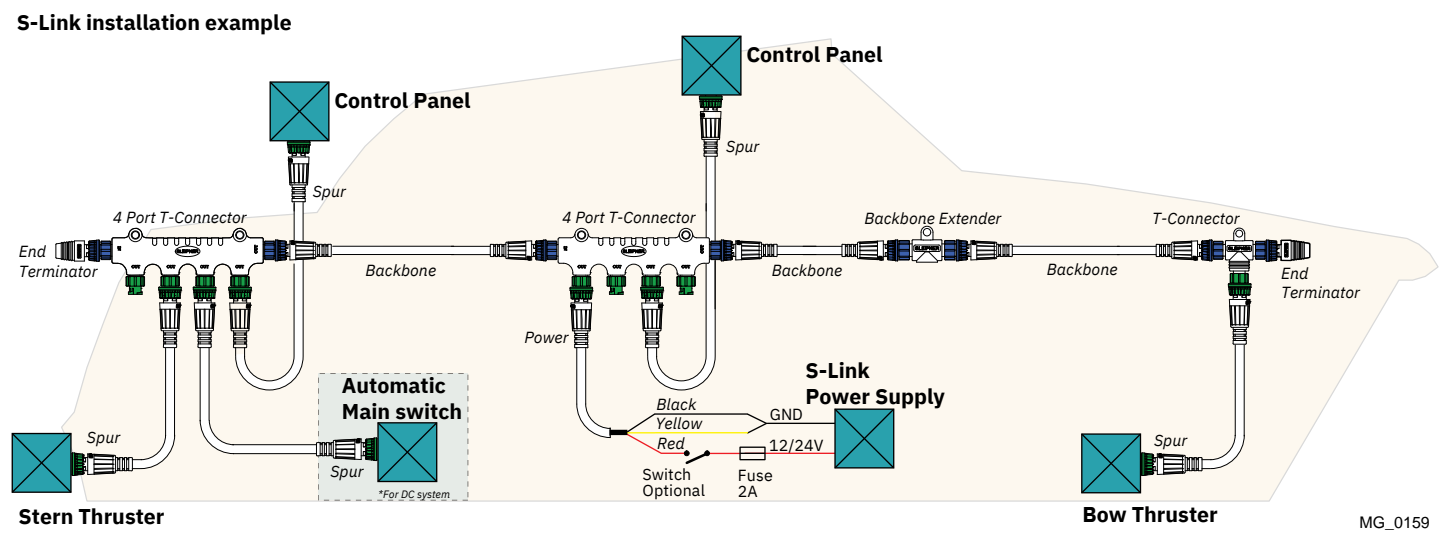
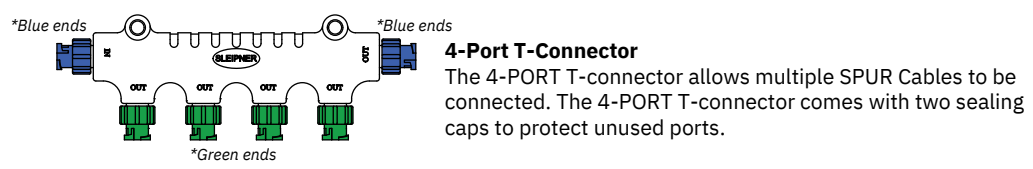

For **Control Panel** installation please refer to the Installation Guide accompanying the control panel to be installed.



- The bolts holding the gear house and motor bracket together are tightened correctly.
- The bolts holding the motor to its bracket are tightened correctly.
- All electrical connections are clean, dry and tight, and the correct cable, fuse and main switch size.
- Check that there is no electrical connection between the electro motor body and positive terminal on the motor, and between the electro motor body and the negative (A1) terminal on the motor with an ohm meter.
- Anti-fouling has been applied to the gear house and propeller but NOT anodes, sealing/ rubber fittings or propeller shafts.
- Propeller is fastened correctly to the shaft.
- Propeller turns freely in tunnel.
- The anode and/ or holding screw is tightened well with thread glue.
- Check the boat for potential water leakage around installation areas.
- Correct drive direction as per control panel.
- User Manual is supplied to the owner.

The thruster has been installed as per the instructions in this manual and all points in checklist above have been controlled.

Signed:

Date:

Thruster type:

Serial number:.....

Date of delivery:.....

Correct drive direction as per control panel:

The compartment for the thruster has been isolated from general bilge water and has no obvious or suspected risks for flooding:

.....
.....
.....

Other comments by installer:

.....
.....

Find your local professional dealer from our certified worldwide network for expert service and support. visit our website www.sleipnergrou.com/support

Product Spare Parts and Additional Resources

For additional supporting documentation, we advise you to visit our website www.sleipnergrou.com and find your Sleipner product.

Warranty statement

1. Sleipner Motor AS (The "Warrantor") warrants that the equipment (parts, materials, and embedded software of products) manufactured by the Warrantor is free from defects in workmanship and materials for purpose for which the equipment is intended and under normal use and maintenance service (the "Warranty").
2. This Warranty is in effect for two years (Leisure Use) or one year (Commercial and other Non-leisure Use) from the date of delivery/purchase by the end user, with the following exceptions;
 - (a) For demonstration vessels, or vessels kept on the water, the dealer is considered as the end user from 6 months after their launch of the vessel;
 - (b) The warranty period starts no later than 18 months after the first launch of the vessel.
 Please note that the boat manufacturer and dealer must pay particular attention to correct maintenance and service both by the products manuals as well as general good practice for the location the boat is kept in the period the boat is in their care. In cases where the 6 and 18 months grace periods for boat builders and dealers are passed, it is possible to obtain a full warranty upon inspection and approval of the warrantor or such representative.
3. Certain parts, classified as wearable or service parts, are not covered by the warranty. A failure to follow the required maintenance and service work as described in the product manual render all warranty on parts or components directly or indirectly affected by this void. Please also note that for some parts, time is also a factor separately from actual operational hours.
4. This Warranty is transferable and covers the equipment for the specified warranty period.
5. The warranty does not apply to defects or damages caused by faulty installation or hook-up, abuse or misuse of the equipment including exposure to excessive heat, salt or fresh water spray, or water immersion except for equipment specifically designed as waterproof.
6. In case the equipment seems to be defective, the warranty holder (the "Claimant") must do the following to make a claim:
 - (a) Contact the dealer or service centre where the equipment was purchased and make the claim. Alternatively, the Claimant can make the claim to a dealer or service centre found at www.sleipnergrou.com. The Claimant must present a detailed written statement of the nature and circumstances of the defect, to the best of the Claimant's knowledge, including product identification and serial nbr., the date and place of purchase and the name and address of the installer. Proof of purchase date should be included with the claim, to verify that the warranty period has not expired;
 - (b) Make the equipment available for troubleshooting and repair, with direct and workable access, including dismantling of furnishings or similar, if any, either at the premises of the Warrantor or an authorised service representative approved by the Warrantor. Equipment can only be returned to the Warrantor or an authorised service representative for repair following a pre-approval by the Warrantor's Help Desk and if so, with the Return Authorisation Number visible postage/shipping prepaid and at the expense of the Claimant.
7. Examination and handling of the warranty claim:
 - (a) If upon the Warrantor's or authorised service Representative's examination, the defect is determined to result from defective material or workmanship in the warranty period, the equipment will be repaired or replaced at the Warrantor's option without charge, and returned to the Purchaser at the Warrantor's expense. If, on the other hand, the claim is determined to result from circumstances such as described in section 4 above or a result of wear and tear exceeding that for which the equipment is intended (e.g. commercial use of equipment intended for leisure use), the costs for the troubleshooting and repair shall be borne by the Claimant;
 - (b) No refund of the purchase price will be granted to the Claimant, unless the Warrantor is unable to remedy the defect after having a reasonable number of opportunities to do so. In the event that attempts to remedy the defect have failed, the Claimant may claim a refund of the purchase price, provided that the Claimant submits a statement in writing from a professional boating equipment supplier that the installation instructions of the Installation and Operation Manual have been complied with and that the defect remains.
8. Warranty service shall be performed only by the Warrantor, or an authorised service representative, and any attempt to remedy the defect by anyone else shall render this warranty void.
9. No other warranty is given beyond those described above, implied or otherwise, including any implied warranty of merchantability, fitness for a particular purpose other than the purpose for which the equipment is intended, and any other obligations on the part of the Warrantor or its employees and representatives.
10. There shall be no responsibility or liability whatsoever on the part of the Warrantor or its employees and representatives based on this Warranty for injury to any person or persons, or damage to property, loss of income or profit, or any other incidental, consequential or resulting damage or cost claimed to have been incurred through the use or sale of the equipment, including any possible failure or malfunction of the equipment or damages arising from collision with other vessels or objects.
11. This warranty gives you specific legal rights, and you may also have other rights which vary from country to country.

Patents

At Sleipner we continually reinvest to develop and offer the latest technology in marine advancements. To see the many unique designs we have patented visit our website www.sleipnergrou.com/patents

© **Sleipner Group**, All rights reserved
The information given in the document
was right at the time it was published.
However, Sleipner Group cannot
accept liability for any inaccuracies or
omissions it may contain. Continuous
product improvement may change the
product specifications without notice.
Therefore, Sleipner Group cannot accept
liability for any possible differences
between product and document.

**Register your product and learn more
at www.sleipnergroun.com**



SLEIPNER GROUP

P.O. Box 519

N-1612 Fredrikstad

Norway

www.sleipnergroun.com

Made in Norway

