



Picture showing the curved handle option

MODEL 2046 MEDIUM DUTY, SINGLE LEVER CONTROL HEAD

The control head 2046 was made for a marine environment and to give the boat owner years of trouble-free service. Its compact and rugged design exceeds any competitive product in value and performance. The control handle will engage the gear in either direction before throttle acceleration takes place. In order to warm up the engine without gear engagement, the control handle is pulled away from the dome approximately $\frac{1}{4}$ ". This will disengage the clutch mechanism and will allow engine acceleration. When the control handle is returned to neutral position, the clutch mechanism is automatically engaged. The control head also provides a small detent in the full throttle position in one direction (forward) only. This will prevent the engine from creeping back resulting in loss of RPM. By reversing the detent roller and spring assembly, the full speed detent can also be reversed.

The clutch travel is maximum 3" (76 mm) and throttle travel is maximum 1-5/8" (41 mm). An optional throttle stroke extension kit is available which will extend the stroke to 2-5/8" (67 mm) and contains all necessary parts to connect either a 33 or 43 series cable.

ORDERING INFORMATION

Model Designations:

- H - With one neutral safety switch
- K - With chrome finish cover and handle
- L - With polished brass finish cover and handle
- M - With black epoxy finish cover with chrome handle
- U - Curved handle
- V - T-bar handle with plastic grip
- Y - T-bar handle
- Z - With riveted metal labels

The standard model 2046 control head is supplied as follows:

- i. With chrome finish cover and handle
- ii. Without neutral safety switch

To order, state model number followed by Model Designation letter codes.

Example: A model 2046 control head with chrome finish would be 2046-K

Notes:

1. Riveted metal labels are available to indicate Neutral, Forward and Reverse positions, as well as the speed scales. To order, add "Z" to the Part No. for example 2046-KYZ
2. Cable connector kits are ordered separately. Each push pull cable end attached to the control head requires one kit.

Ordering Numbers:

- 2046-0901 – #10-32 (30 series) connector kit
- 2046-0902 -- $\frac{1}{4}$ -28 (40 series) connector kit
- 2046-0903 – Neutral Safety Switch kit
- 2046-0905 – throttle extension kit (33 series cable)
- 2046-0906 -- throttle extension kit (43 series cable)

Weight: 7.5 lbs. (3.4 kg)

MODEL 2046

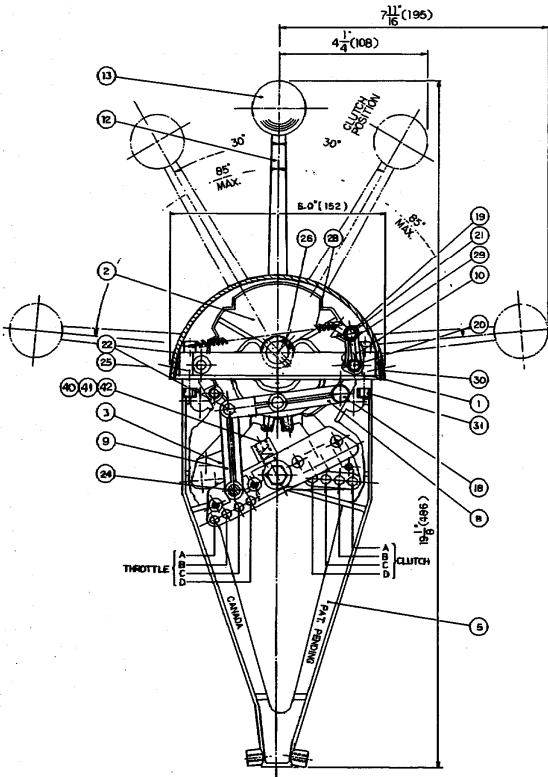

All dimensions in inches (mm)

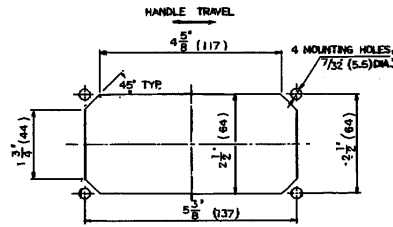

"OUT-OUT" DIMENSIONS

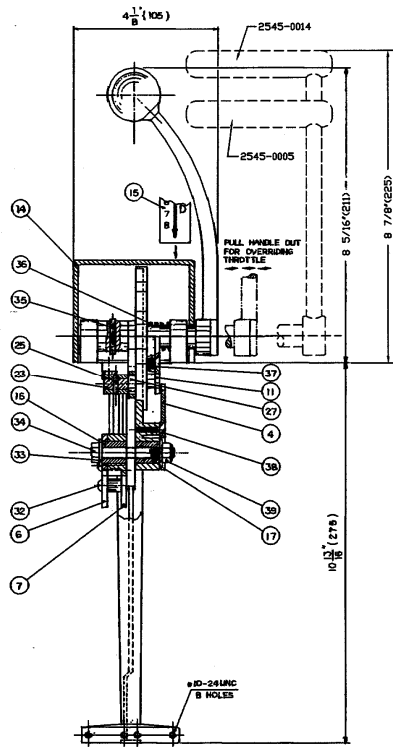

	A	B	C	D
Throttle Travel	1-5/8" (41 mm)	1-3/8" (35 mm)	1-1/16" (27 mm)	13/16" (21 mm)
Clutch Travel	3" (76 mm)	2-1/2" (64 mm)	1-7/8" (48 mm)	1-1/4" (32 mm)

ITEM	QTY	PART NUMBER	DESCRIPTION
1	1	2046-0001	Frame
2	1	2046-0002	Centre Cam
3	1	2046-0003	Pivot Cam
4	1	2046-0004	Retainer
5	1	2046-0005	Support
6	1	2046-0006	End Plate
7	1	2046-0007	Throttle Cam
8	1	2046-0008	Link No. 1
9	1	2046-0009	Link No. 2
10	1	2046-0010	Detent Lever
11	1	2046-0011	Cam Retainer
12	1*	2046-0012	Curved Handle
12	1*	2545-0014	Long Handle
12	1*	2545-0005	Short Handle
12	1*	2545-2014	Long Handle (Plastic Grip)
12	1*	2545-2005	Short Handle (Plastic Grip)
13	1*	2030-0001	Knob
14	1	2004-0002	Dome
15	1*	2046-0115	Label
16	1	2046-0016	Throttle Bushing
17	1	2046-0017	Clutch Bushing
18	1	2046-0018	Shoulder Bolt
19	1	2048-0019	Roller
20	1	2046-0020	Frame Pin
21	1	2046-0020	Detent Link Pin
22	1	2046-0022	Link Pin
23	1	2046-0023	Link Solid Pin
24	1	2046-0024	Pivot Plate Pin
25	2	1024-0510	Spring Pin
26	1	1016-0804	Set Screw
27	1	2046-0027	Throttle Roller
28	1	1202-0002	Spring
29	2	1029-1025	Snap Ring
30	2	1011-0808	Oval Hd Phillips Cap Screw
31	4	1002-1010	Socket Head Cap Screw
32	4	1010-0806	Rd. Hd Phillips Cap Screw
33	2	1023-0237	Washer
34	1	1001-1136	Hex Head Cap Screw
35	1	1024-0816	Spring Pin
36	1	1201-0108	Spring
37	2	1009-0806	Flat Hd Phillips Cap Screw
38	3	1009-0808	Flat Hd Phillips Cap Screw
39	1	1022-0311	Lock Nut
40	1	1016-1204	Set Screw
41	1	1201-0002	Spring
42	1	2542-0008	Friction Pad
43	2	1029-2025	Snap Ring

* Quantity varies with options

How to Install Push Pull Cables on Model 2046

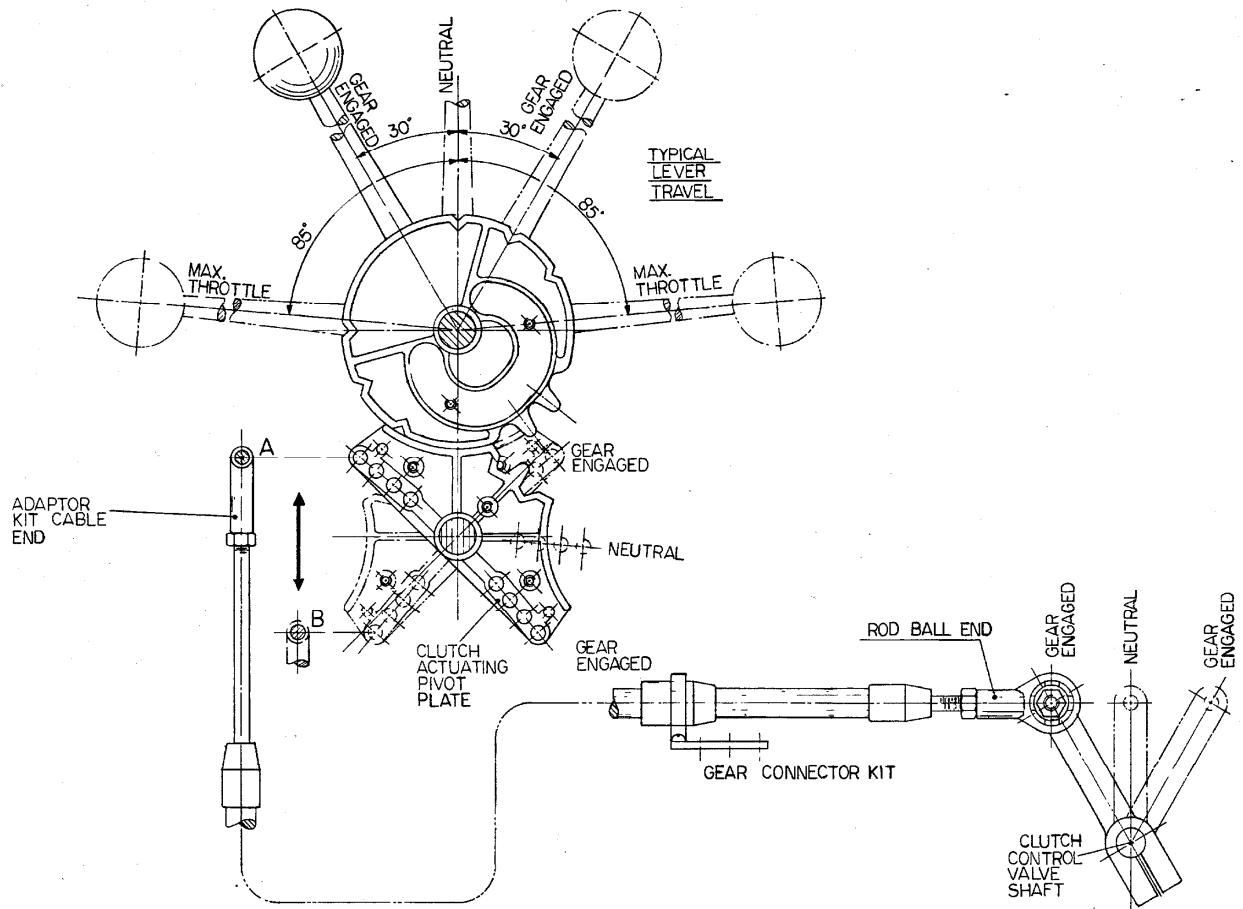

2046, 2048 Connection Kits Installation

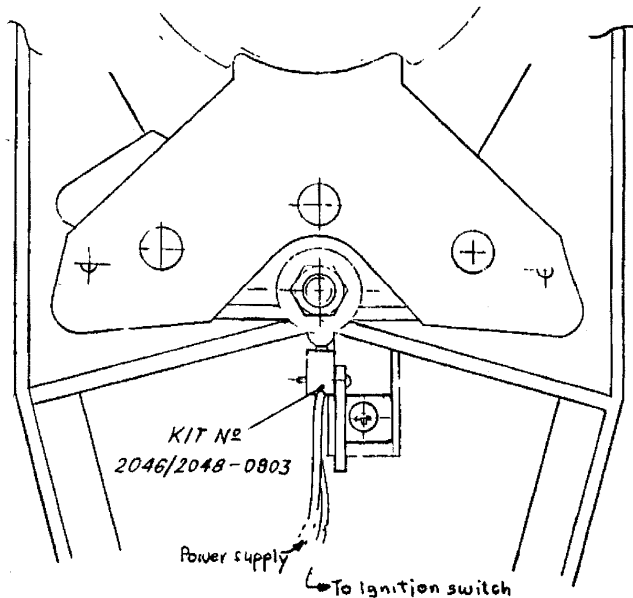

Micro switch (2046-0903) Installation

PRECAUTION: Make sure the switch is installed correctly that the contact and lever is aligned properly with the strike arm and is free from external interference.

Throttle Extension Kit Installation (2046-0905)

Item	Qty	Description
1	2	Pin
2	1	Nut (#10-24)
3	1	Lever
4	1	Rod End
5	1	Hex Head Screw (#10-24 x 7/8")
6	1	Bracket
7	4	Round Head Screw (#10-24 x 1/2")
8	1	Clamp
9	-	-

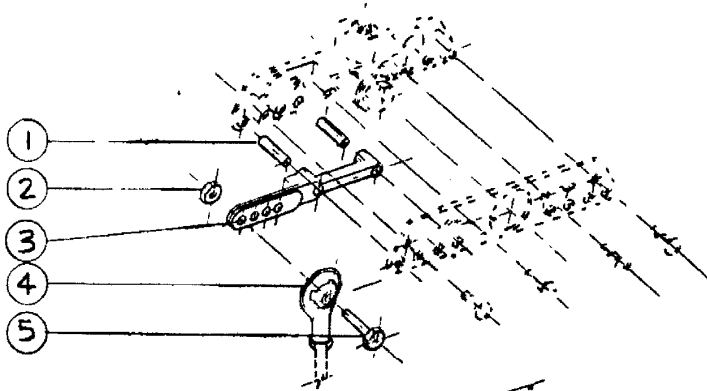

Throttle Extension Kit Installation (2046-0906)

Item	Qty	Description
1	2	Pin
2	1	Nut (#10-24)
3	1	Lever
4	1	Rod End
5	1	Hex Head Screw (#10-24 x 7/8")
6	1	Bracket
7	2	Round Head Screw (#10-24 x 1/2")
8	1	Clamp
9	2	Round Head Screw (#10-24 x 7/8")

